









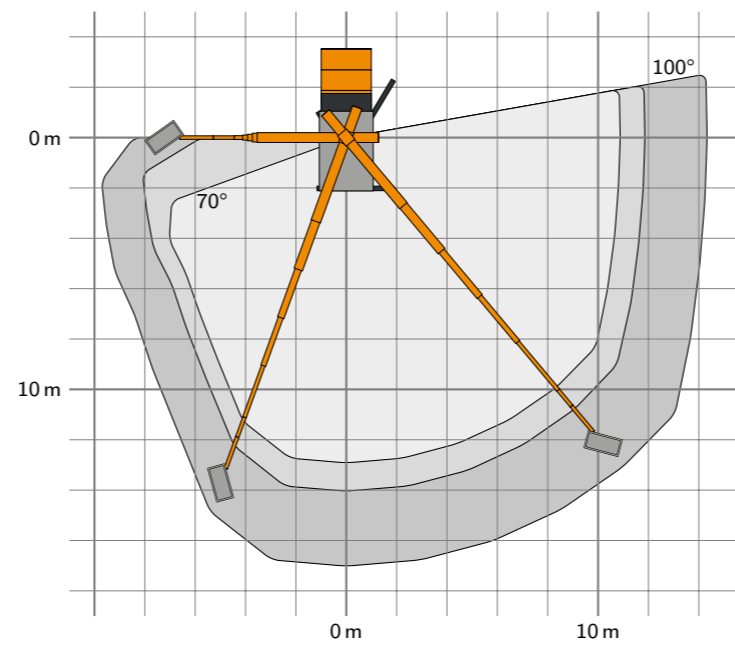
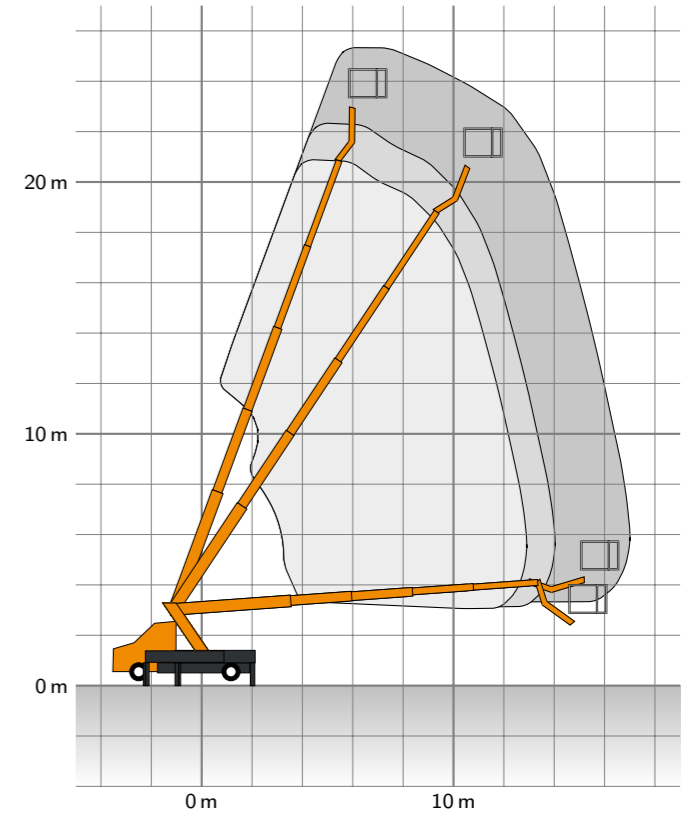
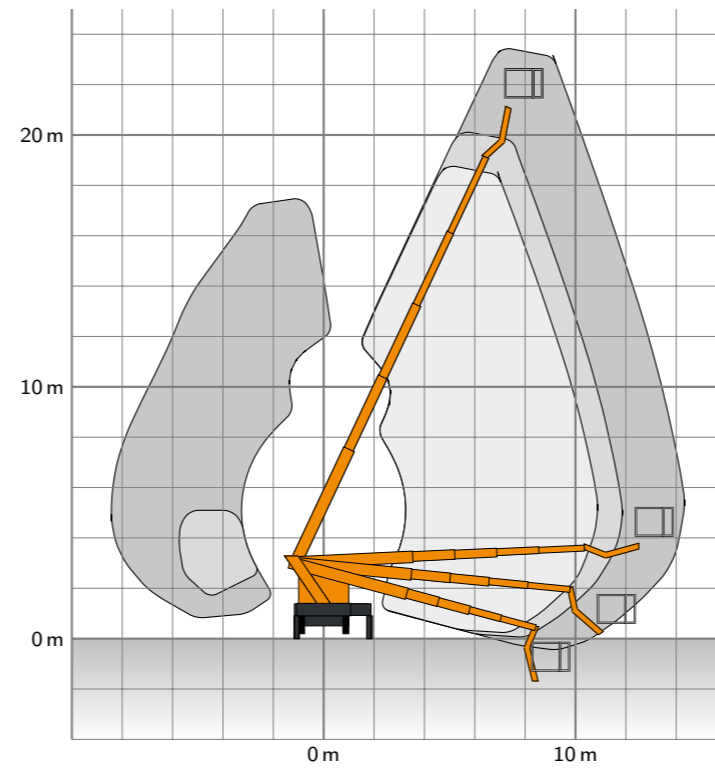

RUTHMANNSTEIGER®	TBR 260
Alu-Bühne	250 kg Nennlast
Trägerfahrzeug	Sprinter 314 CDI 4x2
Zeichnungsnummer	0928518000
Arbeitsbereich	beidseitig voll abgestützt
Aufstellneigung $\leq 0,5^\circ$	Slope $\leq 0,5^\circ$
Alle Maße ca- Maße!	All measures are approx!
Änderungen vorbehalten!	Alterations reserved!
	100 kg Bühnenlast
	200 kg Bühnenlast
	250 kg Bühnenlast
Maßstab: 1:300	3. März 2020
Blatt	1 von 4



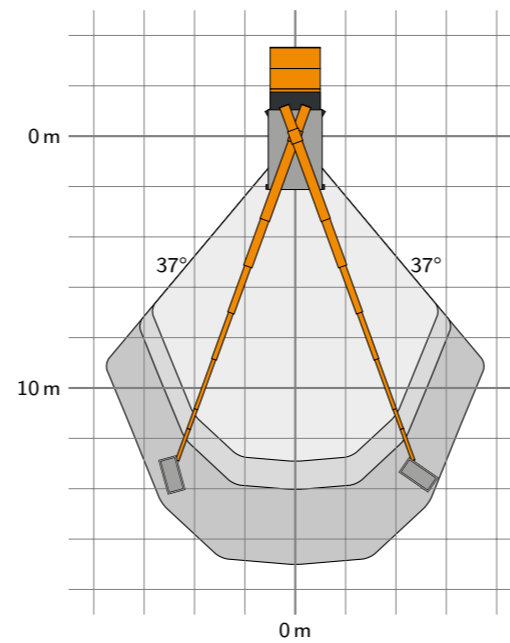
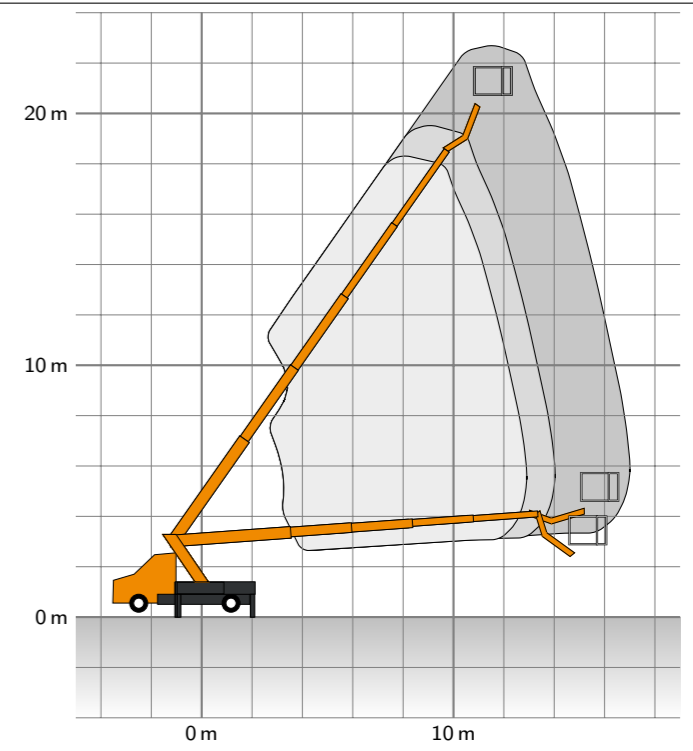

RUTHMANNSTEIGER®	TBR 260
Alu-Bühne	250 kg Nennlast
Trägerfahrzeug	Sprinter 314 CDI 4x2
Zeichnungsnummer	0928518000
Arbeitsbereich	einseitig voll abgestützt
Aufstellneigung $\leq 0,5^\circ$	Slope $\leq 0,5^\circ$
Alle Maße ca- Maße!	All measures are approx!
Änderungen vorbehalten!	Alterations reserved!
	100 kg Bühnenlast
	200 kg Bühnenlast
	250 kg Bühnenlast
Maßstab: 1:300	3. März 2020
Blatt	2 von 4

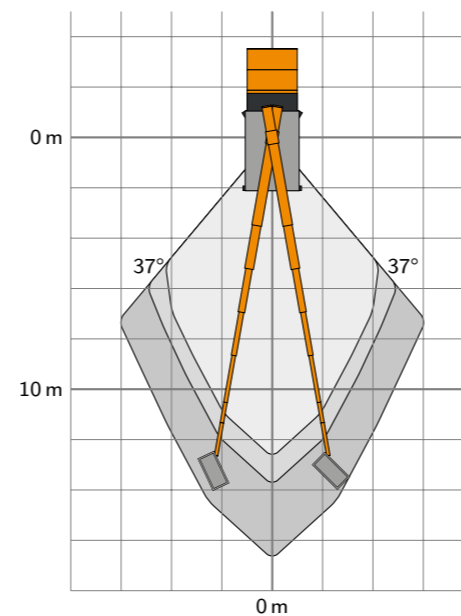
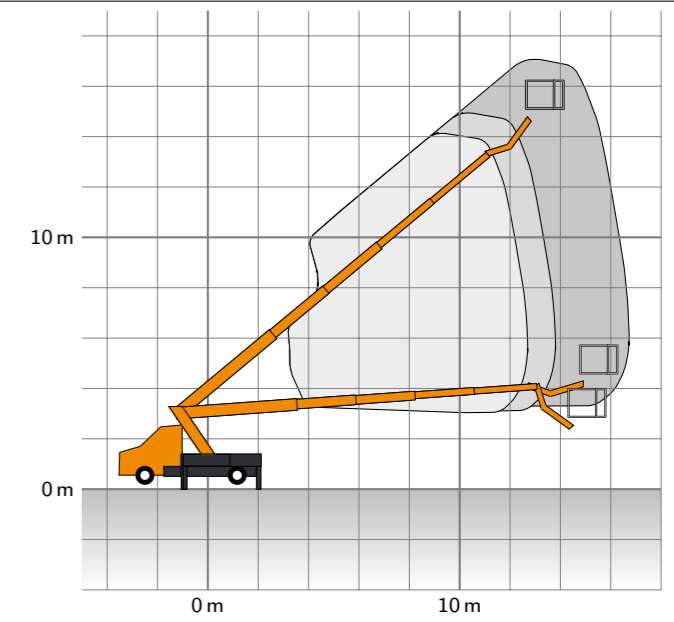

RUTHMANNSTEIGER®	TBR 260
Alu-Bühne	250 kg Nennlast
Trägerfahrzeug	Sprinter 314 CDI 4x2
Zeichnungsnummer	0928518000
Arbeitsbereich	im Profil abgestützt
Aufstellneigung $\leq 0,5^\circ$	Slope $\leq 0,5^\circ$
Alle Maße ca- Maße!	All measures are approx!
Änderungen vorbehalten!	Alterations reserved!
	100 kg Bühnenlast
	200 kg Bühnenlast
	250 kg Bühnenlast
Maßstab: 1:300	3. März 2020
Blatt	3 von 4



RUTHMANNSTEIGER®	TBR 260
Alu-Bühne	250 kg Nennlast
Trägerfahrzeug	Sprinter 314 CDI 4x2
Zeichnungsnummer	0928518000
Arbeitsbereich	Minimalabstützung
Aufstellneigung $\leq 0,5^\circ$	Slope $\leq 0,5^\circ$
Alle Maße ca- Maße!	All measures are approx!
Änderungen vorbehalten!	Alterations reserved!
	100 kg Bühnenlast
	200 kg Bühnenlast
	250 kg Bühnenlast
Maßstab: 1:300	3. März 2020
Blatt	4 von 4